



# ***Patriot***® ***120/120HD***

---

# **OPERATIONS MANUAL**

---

## **Care & Maintenance Instructions**

- Do not discard this manual.
- Keep manual readily available for reference during operation or when servicing product.
- Before operation and maintenance, read and comprehend operations manual content.
  
- **Customer Service:** 800.356.NUMA or 860.923.9551
- **Email:** [numa@numahammers.com](mailto:numa@numahammers.com)
- **Website:** [www.numahammers.com](http://www.numahammers.com)
- **Mailing Address:** P.O. Box 348, Thompson, CT 06277 USA

---

Patents: 6,883,618 7,442,074 10,612,310 11,085,242 EP 3 803 032 B1 KR-101340351 EP-2029325  
CN-101448608 BR-P10711711 AU2007254317 AU2007254317 WO2007/136658



## TABLE OF CONTENTS

	Page
<b>Section I Description .....</b>	<b>1</b>
Functional Description.....	2
1. Backhead.....	2
2. Pin .....	2
3. Check Valve.....	2
4. Check Valve Spring .....	2
5. Feed Tube .....	2
6. Choke.....	2
7. Piston.....	2
8. Case .....	3
8. Snap Ring .....	3
10. Bit Bearing.....	3
11. Bit Bearing Bushing (HD model only).....	3
12. Bit Bearing Retainer .....	3
13. Bit Retaining Rings.....	3
14. Thrust Washers - Brass.....	3
15. Chuck.....	4
16. Chuck Bushing .....	4
 <b>Section II Maintenance .....</b>	 <b>5</b>
Disassembly.....	5
Inspection.....	8
General Assembly .....	11
Hammer Assembly .....	11
Backhead / Feed Tube Assembly .....	11
 <b>Section III Parts Identification .....</b>	 <b>13</b>
Patriot 120/120HD Exploded View.....	13
Part Number Reference.....	13
 <b>Section IV Air Consumption Chart .....</b>	 <b>14</b>
 <b>Section V Lubrication .....</b>	 <b>15</b>
 <b>Section VI Storage .....</b>	 <b>16</b>
Short Term.....	16
Long Term .....	16
Restarting.....	17
 <b>Section VII Button Bit Maintenance .....</b>	 <b>18</b>
General .....	18
Sharpening.....	18
 <b>Section VIII Patriot 120/120HD Recommended Spares.....</b>	 <b>19</b>



**NUMA<sup>®</sup>**  
**HAMMERS AND BITS**  
**WARRANTIES AND REMEDIES**

### **LIMITED WARRANTY**

Numa warrants that the Product will be new and free from defects in material and workmanship under normal use as contemplated by this Contract for a period of six (6) months from the date of shipment.

Except for the foregoing warranty, Numa disclaims all warranties and representations wherever made, including warranties of merchantability, durability, length of service, or fitness for a particular purpose.

Any alteration or modification of the original product without the express written consent of Numa will void this warranty.

### **REMEDY**

If, during such warranty period, Buyer promptly notifies Numa in writing of any defect and establishes that the above warranty is not met, Numa shall either repair or replace the Product or credit the customer, as it deems necessary to meet the warranty.

Such repair, replacement, or credit of Product shall constitute complete fulfillment of Numa's obligation under this warranty, and upon the expiration of the original warranty period, all of Numa's obligations hereunder shall terminate.

### **LIMITATION OF LIABILITY**

Numa shall not be liable to Buyer whether in contract, in tort (including negligence and strict liability), under any warranty or otherwise, for any special, indirect, incidental or consequential loss or damage whatsoever, including (without limitation) loss arising from delay, cost or capital and loss of profits or revenues. The remedies set forth in this Contract are exclusive, and the total cumulative liability of Numa under this Contract or for any act or omission in connection therewith or related thereto, whether in contract, in tort (including negligence and strict liability), under any warranty or otherwise, is limited to the price paid by Buyer for the Product.

The **WARNINGS**, **CAUTIONS** and **NOTES** used throughout the text of this instruction book are defined as follows:

<b>WARNING</b>	A specific procedure or practice that must be strictly followed, or a specific condition that must be met, to prevent possible bodily harm.
<b>CAUTION</b>	A specific procedure or practice that must be strictly followed, or a specific condition that must be met, to prevent damage to the equipment.
<b>NOTE</b>	Important supplemental information.

Numa<sup>®</sup>, Champion<sup>®</sup>, and Patriot<sup>®</sup> are registered trademarks of Numa.

# SECTION I DESCRIPTION

## GENERAL DESCRIPTION

The Patriot 120/120HD is a valveless, pneumatically operated tool designed to utilize Numa 11-7/8" to 17-1/2" (302 mm to 445 mm) diameter bits in rock formations under a wide range of operating conditions. The Patriot 120HD utilizes bit sizes from 12-1/4" to 17-1/2" (311 mm to 445 mm).

The Patriot 120/120HD hammer design incorporates a non-reversible, hardened case. The single bore design allows for a maximum bore diameter in conjunction with optimum life against abrasion. The simple design of the Patriot 120/120HD provides performance and dependability without sacrificing tool life.

The Patriot 120/120HD is designed for universal applications using air pressure from 150 PSI to 250 PSI (10.2 Bar to 17.0 Bar) with compressors having capacities of 1100 CFM (519 Litres/Second) or more. When drilling conditions require supplementary hole cleaning, additional hole cleaning air can be passed through the hammer by utilizing an interchangeable choke. All standard hammers shipped from Numa have a blank choke installed. Refer to page 14 for correct choke selection and pages 7 and 11 to facilitate the removal and the installation of the choke.

<b><i>Patriot 120/120HD</i></b>			
Weight w/o Bit:	P120	1048 lbs.	(475 kg)
	P120HD	1195 lbs.	(543 kg)
Outside Diameter:	P120	10-1/8"	(257 mm)
	P120HD	10-3/4"	(273 mm)
Hammer Length:	Shoulder to Shoulder	66-3/4"	(170 cm)
	Shoulder to Bit Face	75-3/4"	(192 cm)
	Backhead API Thread	6-5/8 API REG	

Table 1-1 General Hammer Specifications

11-7/8"	(302 mm)	384 lbs.	(174 kg)	14"	(356 mm)	442 lbs.	(200 kg)
12-1/4"	(311 mm)	386 lbs.	(175 kg)	15"	(381 mm)	478 lbs.	(217 kg)
12-3/8"	(314 mm)	394 lbs.	(179 kg)	16"	(406 mm)	545 lbs.	(247 kg)
13"	(330 mm)	400 lbs.	(181 kg)	17-1/2"	(445 mm)	571 lbs.	(259 kg)

Table 1-2 General Bit Specifications

**NOTE**

Numa 11-7/8" to 17-1/2" (302 mm to 445 mm) bits are available in concave face design with large air flushing holes and chip ways to take advantage of the Patriot 120/120HD performance. Other sizes may be available upon request.

## FUNCTIONAL DESCRIPTION

### 1. BACKHEAD

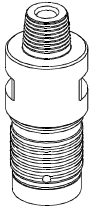

The backhead connects the hammer to the drill rod. It is threaded into the top end of the case with single start threads and into the drill rod with a standard 6-5/8 API REG thread. Wrench flats are provided for disassembling. A 10-3/4" (273 mm) HD backhead is available as an optional extra.

### 2. PIN



The pin connects and aligns the feed tube assembly into the backhead. It is made of hardened steel to insure long life.

### 3. CHECK VALVE



The aluminum check valve maintains pressure in the hammer when the air supply has been shut off. The pressure in the hammer balances the hydrostatic pressure in the hole thereby preventing contaminants from entering the hammer.

### 4. CHECK VALVE SPRING



The check valve spring provides tension under the check valve to keep it closed. It is compressed as the air is turned on.

### 5. FEED TUBE



The feed tube supplies the main air into the chambers located in the piston. It is located in the backhead and held in place by a pin.

### 6. CHOKE



The interchangeable choke is located in the tip of the feed tube and is held in place with a press fit. A set of three chokes is supplied with each hammer. By installing the correct choke, the hammer can be fine tuned to the compressor package. A hammer with a plastic feed tube does not utilize a choke. A hole can be drilled in the bottom tip of the plastic feed tube to facilitate hole cleaning, or pressure control. Use the chart located on page 14 for proper hole size.

### 7. PISTON

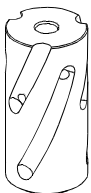

The piston functions as the only moving part in the hammer, controlling the operational air cycle. The percussive action of the piston striking the bit transfers the energy through the bit in order to fracture rock formations. A snap ring inserted in the main bore prevents the piston from sliding out of the case when the chuck, bit, bit retaining rings and bit bearing are removed.

8. **CASE**



The case is designed to contain the internal parts which make up the hammer assembly. The case is non-reversible and hardened to resist wear and to extend life in abrasive conditions. A 10-3/4" (273 mm) OD HD case is also available as an optional extra.

9. **SNAP RING**



A snap ring positions the internal parts in the hammer and prevents the piston from falling out when the chuck, bit retaining rings, bit bearing and bit are removed.

10. **BIT BEARING**



The bit bearing guides the bit to insure proper alignment between the piston and the bit. The bit bearing is placed into the chuck end of the case and is located by a snap ring which is inserted into the main bore. The HD model only has a bit bearing designed for a bit bearing bushing.

11. **BIT BEARING BUSHING (HD MODEL ONLY)**



The bit bearing bushing is a nylon insert located in the I.D. of the bit bearing to provide a bearing surface between the upper bit shank and bit bearing.

12. **BIT BEARING RETAINER**



The bit bearing retainer sits in a groove in the case and retains the bit bearing.

13. **BIT RETAINING RINGS**



The bit retaining rings are designed to allow the bit to move between the drilling and cleaning positions and prevent the bit from coming completely out of the hammer. The bit retaining rings consist of two matched halves and are held together with the bit retaining ring o-ring.

14. **THRUST WASHERS - BRASS**



Two brass thrust washers, one located between the backhead and the case and one between the chuck and the case, provide for easy disassembly.

**15. CHUCK**

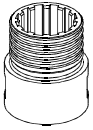

The chuck threads into the bottom end of the case. It has internal splines that mesh with the splines on the bit body to transmit rotation. A 10-3/4" (273 mm) OD HD chuck is available as an optional extra. A 112 chuck is available as an option so that 112 bits can be utilized under this hammer.

**16. CHUCK BUSHING**



The chuck bushing is a nylon insert located in the bottom end of the chuck to provide a bearing surface between the lower bit shank and chuck. A 112 chuck bushing is available as an option when running a 112 chuck.



## SECTION II MAINTENANCE

### **DISASSEMBLY**

- If at all possible, the backhead and chuck should be broken loose on the drill rig; this is much easier than trying to do so after the drill has been removed from the drill rig.

#### **CAUTION**

USE CAUTION WHEN HANDLING DOWN THE HOLE HAMMER PARTS. NUMA HAMMER PARTS ARE MANUFACTURED FROM HARDENED, HEAT TREATED MATERIALS. DROPPING OR STRIKING THESE PARTS MAY CAUSE SEVERE DAMAGE. STRIKING THE HAMMER PARTS WITH HAMMERS, CROWBARS OR LIKE INSTRUMENTS WILL VOID THE WARRANTY.

- Maintenance should be performed in a clean environment.
- Tools needed: appropriate hammer lifting device, a hammer stand, chain vise, 2" (51 mm) diameter brass rod, a press, a drift pin and a small screwdriver.
- Clean the outside of the hammer. This will insure a good surface to clamp on.
- With the hammer standing in the vertical position, using an appropriate lifting device, unscrew and remove the chuck/bit assembly from the case.
- Remove the bit retaining rings from around the bit.
- Remove the o-ring from the bit retaining rings.
- Remove the chuck from the bit.
- Remove the drive plates from the bit and chuck splines.
- Remove the brass thrust washer from the chuck.
- Using an appropriate lifting device, unscrew and remove the backhead/feed tube assembly from the case.
- Place the hammer horizontally on a hammer stand and secure the hammer with a chain vise.

#### **CAUTION**

THE ACCEPTABLE CLAMPING AREAS START 8" (203 MM) FROM EITHER CASE END, TO AN ADDITIONAL 5" (127 MM) BEYOND THIS POINT. PLACING THE CHAIN VISE ON THE AREA OF THE CASE WHERE THE PISTON CYCLES CAN DISTORT THE CASE, RESTRICT PISTON MOVEMENT AND VOID THE WARRANTY.

- With the case in a horizontal position and using a 2" (51 mm) diameter brass rod, slide the piston out of the backhead end of the case.
- Removal of the chuck bushing is not necessary for routine maintenance. If necessary, lay the chuck on its side so that the bit end is facing you. Locate the seam in the chuck bushing. Insert a screwdriver into the slot in the middle of the seam and pry the chuck bushing from the under cut. Remove the chuck bushing from the bit end of the chuck.
- Removal of the bit bearing, bit bearing bushing (in HD model only), and snap ring from the chuck end of the case is not necessary for routine maintenance. If necessary, use a small screw driver or similar device to pick out the bit bearing retainer from the groove. Insert the bit bearing press plate into the backhead end of the case with the small diameter toward the chuck end. Using a 2" (51 mm) diameter brass rod, slide the bit bearing press plate to the chuck end of the case until it rests against the bit bearing. Remove the brass rod. Using a press, apply pressure to the bit bearing press plate and force the bit bearing and snap ring out of the chuck end of the case. On HD model only, use a small screw driver or similar device to pick out the bit bearing bushing from the I.D. of the bit bearing.
- To disassemble the backhead / feed tube assembly, stand the backhead / feed tube assembly on a bench, with the API thread facing down.

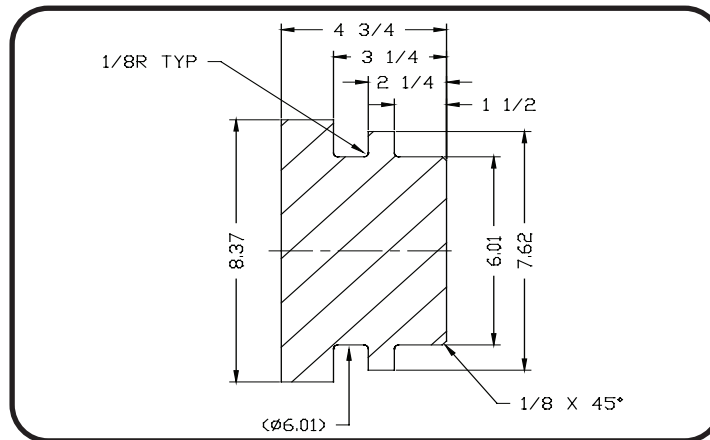

**P120/120HD Bearing Spacer/Press Plate**  
**Figure 2-1**

- Using a drift pin, tap the pin out of the backhead/feed tube assembly.
- Lift the feed tube assembly out of the backhead.
- Removal of the plug and choke are not necessary for routine maintenance. If necessary, use a 3/8" (10 mm) diameter, 24" (610mm) long rod and tap out the choke downward, toward the plug. Continue tapping both the plug and choke out of the feed tube. A hammer with a plastic feed tube does not utilize a choke.
- Remove the brass thrust washer from the backhead.
- Remove the feed tube o-ring from the backhead inside diameter.
- Remove the check valve and check valve spring.
- Remove the backhead o-rings from the backhead outside diameter.

## ***INSPECTION***

- All parts should be washed in a clean solvent before they are inspected and reassembled.

**WARNING**  
USE CLEANING FLUIDS THAT ARE NONFLAMMABLE AND AVOID  
BREATHING THE FLUID VAPORS.

- Handle all parts carefully, hardened parts may chip if dropped on a hard surface.

## ***BACKHEAD***

- Inspect the threads and pin hole for cracks and burrs.
- Remove all burrs on the thread with a fine file or emery cloth.
- Replace if necessary.

## ***CHECK VALVE***

- The check valve should be smooth and free from abrasions.
- Replace if necessary.
- Replace the check valve spring if it is worn or broken.

## ***FEED TUBE ASSEMBLY***

- Inspect the outside diameters for nicks, burrs and scoring.
- Inspect all makeup surfaces for indentations or nicks caused by wear.
- Remove all minor irregularities with emery cloth.
- Replace if necessary.

## ***PIN***

- Inspect pin for scoring or cracks.
- Replace if necessary.

### **SNAP RING**

- Inspect the snap ring for severe wear indications.
- Remove or round over any sharp edges.
- Replace if necessary.

### **PISTON**

- Inspect the striking face, inside and outside diameters for nicks, scoring and cracks.
- Polish the piston with emery cloth to remove all minor irregularities, cracked pistons should be replaced.
- Wash the piston thoroughly, inside and out, to remove all emery dust.

### **CASE**

- Inspect the outside diameter for excessive wear or cracks. Inspect the internal case bore for scoring.
- Remove all minor irregularities with fine honing stones.
- Clearance between the case and piston should not exceed .020" (0.5 mm).

### **BIT BEARING**

- In HD model only, inspect the bit bearing bushing for cracks or irregularities. Replace if necessary.
- Inspect the inside and outside for nicks and burrs.
- Remove all internal irregularities with a polishing wheel.
- Remove all external irregularities with an emery cloth.
- Clearance between the bit bearing and the bit shank should not exceed .030" (0.7 mm).
- Replace if necessary.

### ***BIT RETAINING RINGS***

- Inspect for cracks or deformations.
- Remove all irregularities with a file or emery cloth.
- Replace if necessary.

### ***CHUCK***

- Inspect the chuck bushing for cracks or irregularities. Replace if necessary.
- Inspect for cracks and burrs.
- For continued use, the outside diameter should be larger than the outside of the case or the same. Collar length should not be less than 5.250" (133 mm).

#### **CAUTION**

**IF THE COLLAR LENGTH IS LESS THAN 5.250" (133 MM) AND THE BIT IS UNDER LOAD CONDITIONS, CONTACT BETWEEN THE SHOULDER OF THE BIT RETAINING RINGS AND THE BOTTOM OF THE BIT RETAINING RING AREA ON THE BIT, COULD CAUSE THE BIT TO FAIL IN THIS AREA.**

- Torsional play in the splines should not exceed .200" (5.0 mm).
- Replace if necessary.

### ***O-RINGS***

- Inspect for damage such as cracks and deformations.
- Replace if necessary.

### ***THRUST WASHERS - BRASS***

- Inspect for damage such as cracks and deformations.
- Replace if necessary.

## **GENERAL ASSEMBLY INSTRUCTIONS**

- Assembly should be performed in a clean environment.
- All parts should be cleaned thoroughly and wiped dry before assembly.
- Oil all parts by hand using Rock Drill Oil to insure easy assembly.
- Coat all thread connections with a thread compound to allow joints to thread easily.

## **HAMMER ASSEMBLY**

- Using the 2" (51 mm) brass rod, install the thick snap ring into the groove, located in the chuck end of the case.
- In HD model only, insert the bit bearing bushing into the bit bearing.
- Install the bit bearing in the case, until it seats against the snap ring.
- Install the round bit bearing retainer in the groove at the shoulder of the bit bearing.
- Install the thrust washer against shoulder of the chuck threads and insert the chuck bushing in the ID under cut of the chuck. With the bit face down, place the chuck over the top of the bit. Align the splines and lower the chuck completely onto the bit.
- Place the bit retaining rings, with the bit retaining ring o-ring installed, over the bit shank and on top of the chuck.

## **BACKHEAD / FEED TUBE ASSEMBLY**

- Place the backhead on the bench with the API threads facing down. Install the backhead o-rings into the grooves located on the thread diameter.
- Place the feed tube o-ring into the groove located in the inside of the backhead.
- Place the check valve and check valve spring in the backhead.
- Drop the choke into the feed tube and using the small rod, tap the choke in place. A hammer with a plastic feed tube does not utilize a choke.
- Using a drift pin, tap the plug into the feed tube until it seats against the shoulder.
- Using a rubber mallet, tap the feed tube into the backhead, aligning the hole in the feed tube with the hole in the backhead.

- Using a rubber mallet, tap the pin into the hole.
- Place the thrust washer over the backhead threads until it rests against the backhead shoulder.

### **HAMMER ASSEMBLY CONTINUED**

- Place the hammer horizontally on a hammer stand and secure with a chain vise.

#### **CAUTION**

THE ACCEPTABLE CLAMPING AREAS START 8" (203 MM) FROM EITHER CASE END, TO AN ADDITIONAL 5" (127 MM) BEYOND THIS POINT. PLACING THE CHAIN VISE ON THE AREA OF THE CASE WHERE THE PISTON CYCLES CAN DISTORT THE CASE, RESTRICT PISTON MOVEMENT AND VOID THE WARRANTY.

- Slide the piston in the backhead end of the case. Push the piston all the way to the chuck end. The piston should ride in the case very smoothly.
- Using an appropriate lifting device, stand the hammer case up in a vertical position with the chuck end on the ground.
- Using an appropriate lifting device, lower the backhead / feed tube assembly into the case. Thread the backhead / feed tube assembly into the case until it shoulders up.
- Using an appropriate lifting device, lower the hammer assembly over the chuck/bit assembly. Thread the chuck/bit assembly into the case and hand tighten. The chuck should shoulder against the thrust washer and case, with no gap present.

#### **CAUTION**

DUE TO CLOSE TOLERANCES BETWEEN THE PATRIOT 120/120HD INTERNAL PARTS AND THE CASE, NUMA CAN NOT ACCEPT RESPONSIBILITY FOR DAMAGE CAUSED BY WELDING ON THE CASE OD. WELDING ON THE CASE CAN CREATE DISTORTION, CAUSE PREMATURE FAILURE AND VOID THE WARRANTY. CONTACT NUMA FOR SPECIAL INSTRUCTIONS IF WELDING THE CASE BECOMES UNAVOIDABLE.



# SECTION III PARTS IDENTIFICATION EXPLODED VIEW

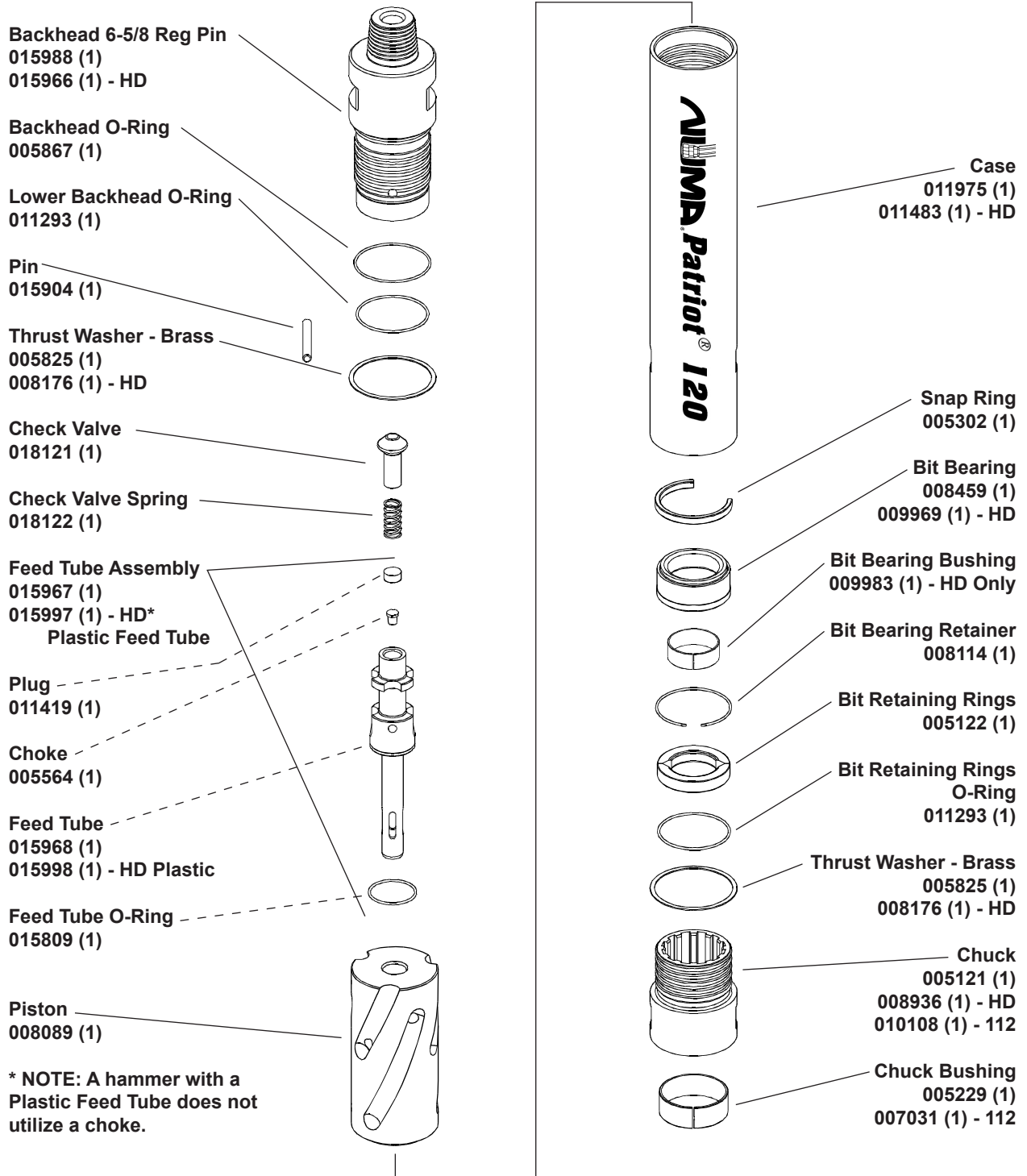

\* NOTE: A hammer with a Plastic Feed Tube does not utilize a choke.

**Hammer Assembly #015989 / HD #015977 / 112 Bits #015976**

*Figure 3-1*

## SECTION IV AIR CONSUMPTION CHARTS PATRIOT 120/120HD

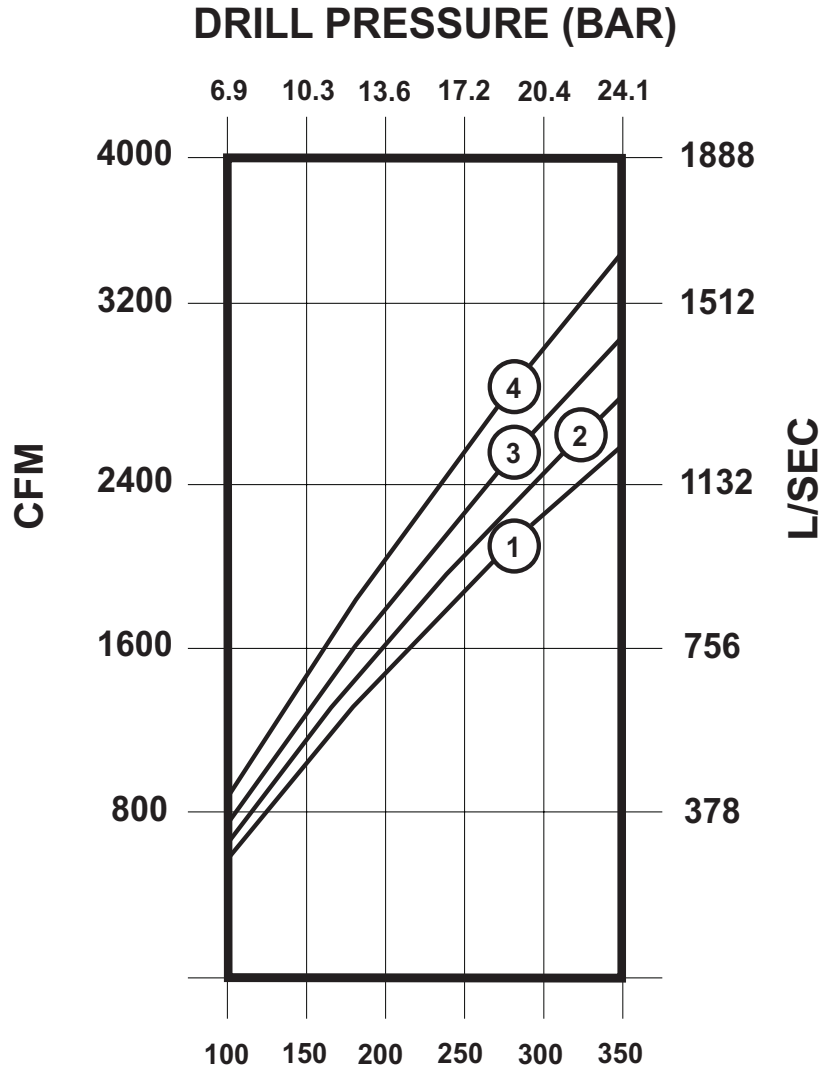

- ① SOLID CHOKE
- ③ 3/8 (9.5mm) CHOKE
- ② 1/4 (6.4mm) CHOKE
- ④ 1/2 (12.7mm) CHOKE

## SECTION V LUBRICATION

The Patriot 120/120HD hammer requires a continuous supply of the correct type Rock Drill Oil. The Patriot 120/120HD hammer consumes at least 5 quart (5 litres) of Rock Drill Oil per hour in order to maintain adequate lubrication. See table 5-1 for recommended Rock Drill Oil.

	Medium SAE 30	Heavy SAE 50
Shell	Air Tool Oil S2 A 150	Air Tool Oil S2 A 320
Texaco / Caltex	Rock Drill Lube 100	Rock Drill Lube 320
Chevron	Vistac 150	Vistac 320
Conoco	Conoco 150	Conoco 320
Numa Bio Blend	RDP 150	RDP 320

Table 5-1  
Recommended Rock Drill Oil

### CAUTION

ROCK DRILL OILS AND NUMA ENVIRO LUBE ARE THE ONLY ACCEPTABLE LUBRICANTS. SAE 50 ROCK DRILL OIL SHOULD BE USED IN AMBIENT TEMPERATURES OF 80° FAHRENHEIT (27° CELSIUS) OR HIGHER. CONTACT NUMA FOR ACCEPTANCE OF ALTERNATIVE ROCK DRILL LUBRICANTS.

### CAUTION

THE PATRIOT 120/120HD, AS WITH ANY MACHINE, REQUIRES CONTINUOUS LUBRICATION. THE FAILURE TO SUPPLY ADEQUATE LUBRICATION TO THE HAMMER CAN CAUSE PREMATURE FAILURE AND MAY VOID THE WARRANTY.

## **SECTION VI STORAGE**

When storing a Patriot hammer, it is important to take the necessary steps in order to insure a smooth operation after restarting.

When the hole is completed and the hammer is to be inactive for several weeks or longer the following steps should be followed:

Each drill rod should be blown clear of all water. During this process, turn on the in line lubricator and blow until the rock drill oil can be seen from the bottom end of each drill rod. In addition, each rod (pin and box end) should be wiped clean and capped to prevent foreign contaminants from sticking to the connector ends.

### ***SHORT TERM STORAGE***

When the Patriot hammer will be stored for only a short period of time the following steps should be taken:

- Blow the hammer clear of all water.
- Pour one cup of Rock Drill Oil into the backhead.
- Turn the air on and cycle for 10 seconds. This will lubricate the internal parts.
- Cap the backhead and chuck end.
- Store the hammer horizontally in a dry environment.

### ***LONG TERM STORAGE***

When the Patriot hammer will be stored for a long period of time the following steps should be taken:

- Blow the hammer clear of all water.
- If at all possible, the backhead and chuck should be broken loose on the drill rig, this is much easier than trying to do so in the shop.
- Disassemble the hammer.
- Inspect and wipe all the parts clean.

- Lubricate all the internal parts with Rock Drill Oil. See table 5-1 on page 16 for suitable Rock Drill Oils.
- Cap the backhead and chuck ends.
- Store the hammer horizontally in a dry environment.

## ***RESTARTING***

Before restarting the hammer after prolonged periods of inactivity, disassemble and inspect all internal hammer parts.

If any internal hammer parts have oxidized, use an emery cloth to polish each part. Wash each hammer part, wipe dry, relubricate with rock drill oil and reassemble the hammer.

**CAUTION**  
FAILURE TO CHECK INTERNAL PARTS BEFORE RESTARTING THE HAMMER  
MAY CAUSE SERIOUS DAMAGE TO THE HAMMER.

## SECTION VII BUTTON BIT MAINTENANCE

### GENERAL

Numa button bits are designed for fast penetration and long life. Keeping the carbide buttons sharp has a direct effect on both the penetration and the tool life.

As the bit wears flat, spots develop on the carbide buttons. These flat spots increase stress on the buttons causing the bit to work harder, which may cause button failure. Bit sharpening can minimize these problems.

Gauge buttons will usually show the most wear and should be used to determine the frequency of bit sharpening. When the flats on the gauge buttons become a maximum of 1/8" (3 mm) wide it is time to resharpen. Refer to figure 7-1.

### SHARPENING

The following tools are required to resharpen the bit:

- Hand grinder (20,000 r.p.m.)
- Silicon carbide wheel 1" (25 mm) diameter, 60 - 80 grit
- Bit stand
- Pencil

Place a mark on the center of the button flat. Grind the button to its original shape leaving the mark untouched. Refer to figure 7-1. It is important to leave the center of the flat untouched to insure concentricity.

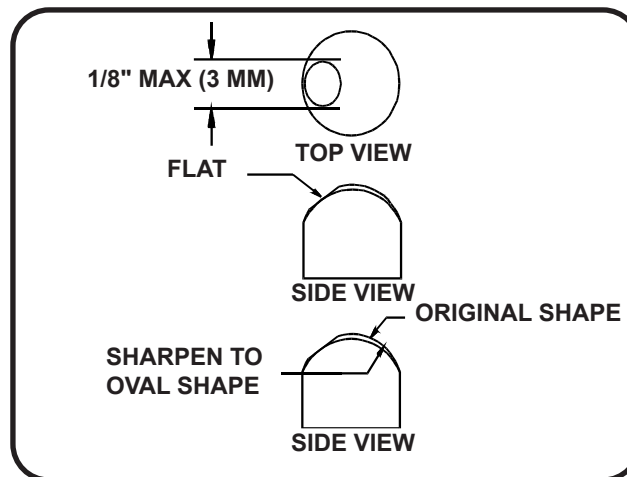

Button Resharpening

Figure 7-1

## SECTION VIII RECOMMENDED SPARES Patriot 120/120HD

Product Description	Part Number	Class 1	Class 2
Backhead 6-5/8 Reg Pin	015988	0	1
Backhead O-Ring	005867	1	2
Lower Backhead O-Ring	011293	1	2
Thrust Washer - Brass	005825	2	4
Pin	015904	1	2
Check Valve	018121	1	2
Check Valve Spring	018122	1	2
Feed Tube Assembly	015967	1	2
Plug	011419	1	2
Choke (Blank)	005564	0	1
Feed Tube	015968	1	2
Feed Tube O-Ring	015809	1	2
Piston	008089	0	1
Case	011975	0	1
Snap Ring	005302	1	2
Bit Bearing	008459	0	1
Bit Bearing Retainer	008114	1	2
Bit Retaining Rings	005122	1	2
Bit Retaining Rings O-Ring	011293	1	2
Chuck	005121	0	1
Chuck Bushing	005229	1	2
Choke Set (not Plastic Feed Tube)	007121	1	2
Choke Blank - installed in hammer	005564	0	1
Choke 1/4"	007122	0	1
Choke 3/8"	008045	0	1
Choke 1/2"	007123	0	1
<b>Alternate Parts</b>			
Backhead 6-5/8 Reg Pin (HD)	015996	0	1
Thrust Washer - Brass (HD)	008176	2	4
Feed Tube Assembly (HD - Plastic)	015997	1	2
Plug	011419	1	2
Feed Tube	015998	1	2
Feed Tube O-Ring	015809	1	2
Case (HD)	011483	0	1
Bit Bearing (HD)	009969	0	1
Bit Bearing Bushing (HD Only)	009983	1	2

Product Description	Part Number	Class 1	Class 2
Chuck (HD)	008936	0	1
Chuck (112)	010108	0	1
Chuck Bushing (112)	007031	1	2

*For Complete Hammer Assembly #015989 / HD #015977 / 112 Bits #015976  
Table 8-1*

**NOTE**

- Class 1 Represents a user of a Patriot 120/120HD hammer that has readily available spare parts.
- Class 2 Represents a user of a Patriot 120/120HD hammer that does not have readily available spare parts.



**NOTES**

**NOTES**